

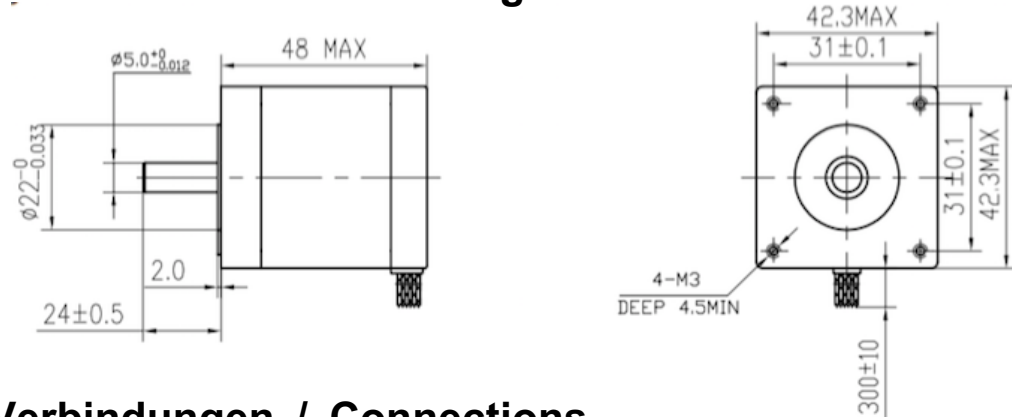

### Spezifikationen / Specifications

Phase	2 Phase
Step Angle / Schrittwinkel	0.9° ± 5% / Step
Voltage / Nennspannung	2.4 V
Current / Nennstrom	0.8 A/Phase
Resistance / Widerstand	0.8 ± 10% Ω/Phase
Inductance / Induktanz	1.8± 20% mH/Phase
Holding Torque / Haltemoment	42 N.cm Min
Detent Torque / Rastmoment	2.2 N.cm Max
Insulation Class / Isolierungs Klasse	B
Lead Style / Kabel Art	AWG26 UL1007
Rotor Torque / Rotorträgheit	68 g.cm <sup>2</sup>

### Mechanische Abmessungen / Mechanical Dimensions



### Verbindungen / Connections

### Haltemoment Kurve / Torque Curve

